

## 6003 Joker Combination wrench, 14 x 167 mm

6003 Joker Combination wrench - Open end with return angle of just 15°. When things get tight.

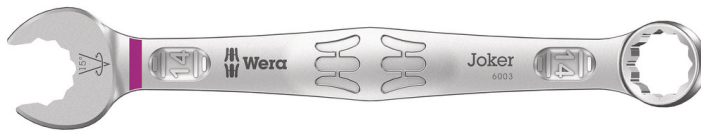

<b>EAN:</b>	4013288212702	<b>Size:</b>	249x50x23 mm
<b>Part number:</b>	05020205001	<b>Weight:</b>	93 g
<b>Article number:</b>	6003 Joker	<b>Country of origin:</b>	CZ
		<b>Customs tariff number:</b>	82041100

- Especially suitable for tight spaces
- The special open end geometry expands the placement possibilities of the tool
- The low return angle in the open end "takes" the screw every 15°
- Slim ring side with 15° crank
- With Take it easy tool finder: colour coding by size

As installation spaces become increasingly confined, tools are necessary that enable users to work successfully even in such situations. Narrow spaces require additional placement points of the tool. Can spanners be modified so that the placement possibilities of the tool increase? The combination of the 7.5° offset open end and the double hexagon geometry doubles the placement points. A repeated 180° turn of the wrench around the longitudinal axis during screwdriving provides four placement possibilities, and bolts or screw heads can be engaged every 15°. The Joker 6003 with its smart open end geometry significantly expands the range of uses in confined spaces. The Joker 6003 will automatically find the respective placement point after every turn. The slim yet robust ring side is tilted by 15° to the tool axis. The high-quality surface treatment achieves a high and long-lasting corrosion protection. With tool finder Take it easy: colour coding by size.

### Web link

[https://products.wera.de/en/joker\\_6003\\_joker\\_combination\\_wrench\\_open\\_end\\_with\\_return\\_angle\\_of\\_just\\_15\\_when\\_things\\_get\\_tight\\_6003\\_joker.html](https://products.wera.de/en/joker_6003_joker_combination_wrench_open_end_with_return_angle_of_just_15_when_things_get_tight_6003_joker.html)

Wera - 6003 Joker  
05020205001 - 4013288212702

Wera Werkzeuge GmbH  
Korzter Straße 21-25  
D-42349 Wuppertal  
Tel: +49 (0)2 02 / 40 45-0  
E-Mail: [info@wera.de](mailto:info@wera.de)

## 6003 Joker Combination wrench, 14 x 167 mm

6003 Joker Combination wrench - Open end with return angle of just 15°. When things get tight.

For very tight spaces



The Joker 6003 ring spanner with its special open end geometry - open end offset by 7.5° and the double hexagon profile - doubles the placement possibilities when repeatedly turning the wrench 180° around the longitudinal axis. Bolts and screw heads can be "accessed" every 15°. The Joker 6003 will automatically find the respective placement point after every turn.

Joker 6003: For return angles of less than 30°



Thanks to the open end side offset by 7.5°, double hexagon geometry and an adjusted application method (placement - screwdriving - turning - replacement - screwdriving - turning, etc), even screwdriving challenges allowing a return angle of less than 30° can be solved.

Double-hex geometry

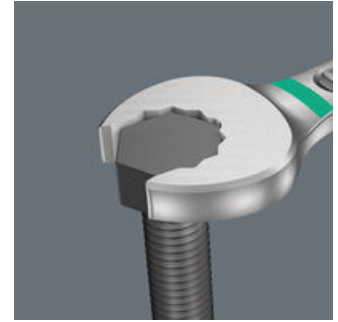

The double hexagon geometry on the open end and ring sides secures the positive connection with the screw head or bolt and reduces the risk of slipping.

Joker 6003: Tilted ring side

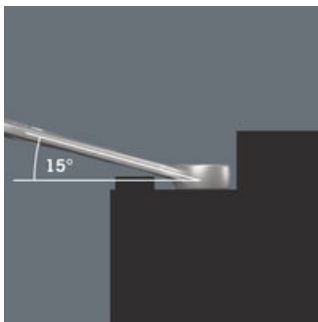

The ring side is tilted at 15° to the tool axis to prevent injury.

"Take it easy" tool finder



Take it easy tool finder system - with profile and size colour-coding for quick and easy tool selection. Colour-coded system for hexagon drive screws (L-Keys, Zyklus bit sockets), external hex drive screws and nuts (Joker wrenches, Zyklus sockets and Zyklus bit sockets with holding function), and TORX® drive screws (L-Keys, Zyklus bit sockets).

### Web link

[https://products.wera.de/en/joker\\_6003\\_joker\\_combination\\_wrench\\_open\\_end\\_with\\_return\\_angle\\_of\\_just\\_15\\_when\\_things\\_get\\_tight\\_6003\\_joker.html](https://products.wera.de/en/joker_6003_joker_combination_wrench_open_end_with_return_angle_of_just_15_when_things_get_tight_6003_joker.html)

Wera - 6003 Joker  
05020205001 - 4013288212702







Wera Werkzeuge GmbH  
Korzerter Straße 21-25  
D-42349 Wuppertal  
Tel: +49 (0)2 02 / 40 45-0  
E-Mail: [info@wera.de](mailto:info@wera.de)

## 6003 Joker Combination wrench, 14 x 167 mm



6003 Joker Combination wrench - Open end with return angle of just 15°. When things get tight.

Further versions in this product family:

							
		mm	mm	mm	mm	mm	mm
05020190001	leuchtorange_152C	5.5	105	16	4	10	6
05020198001	blau_307C	6	105	16	4	10	6
05020199001	gelb_123C	7	110	17.7	4.2	11.5	6
05020200001	leuchtpink_232C	8	115	19	4.5	12.5	7
05020219001	gruen_363C	9	120	21	4.8	13.5	7
05020201001	leuchtgelb_yello wC	10	125	22	5	15	7
05020202001	cyan_2985C	11	135	24.5	5	17	8
05020203001	schwarz_blackC	12	148	26	5.5	18	8.5
05020204001	tuerkis_339C	13	160	27	6	19	8.5
<b>05020205001</b>	<b>pink_241C</b>	<b>14</b>	<b>167</b>	<b>29</b>	<b>6</b>	<b>20</b>	<b>8.5</b>
05020206001	weiss	15	174	32	6	22	8.5
05020207001	violett_2735C	16	182	35	6.5	23	10
05020208001	rot_200C	17	190	38	6.5	24.5	10
05020209001	leuchtgruen_375C	18	210	39	7.5	26	11.5
05020210001	blau_307C	19	230.0	42	7.5	27.5	11.5
05020500001	leuchtpink_232C	20	230.0	45	7.5	29	13
05020501001	gruen_363C	21	260	47	7.5	30	13
05020502001	leuchtgelb_yello wC	22	260	49	7.5	31.5	13
05020503001	cyan_2985C	24	280	53	8	36	14
05020504001	schwarz_blackC	27	300	60	8.5	40	14.5
05020505001	tuerkis_339C	30	330	66	9	43	16
05020506001	pink_241C	32	360	70	9.5	45.5	16.5
05020507001	violett_2735C	36	460	80	10	50.5	18

### Web link

[https://products.wera.de/en/joker\\_6003\\_joker\\_combination\\_wrench\\_open\\_end\\_with\\_return\\_angle\\_of\\_just\\_15\\_when\\_things\\_get\\_tight\\_6003\\_joker.html](https://products.wera.de/en/joker_6003_joker_combination_wrench_open_end_with_return_angle_of_just_15_when_things_get_tight_6003_joker.html)

Wera - 6003 Joker  
05020205001 - 4013288212702

Wera Werkzeuge GmbH  
Korzter Straße 21-25  
D-42349 Wuppertal  
Tel: +49 (0)2 02 / 40 45-0  
E-Mail: info@wera.de